

PROFILO P4

Elaborato 3 Sezioni di verifica
3.3 Profilo P4

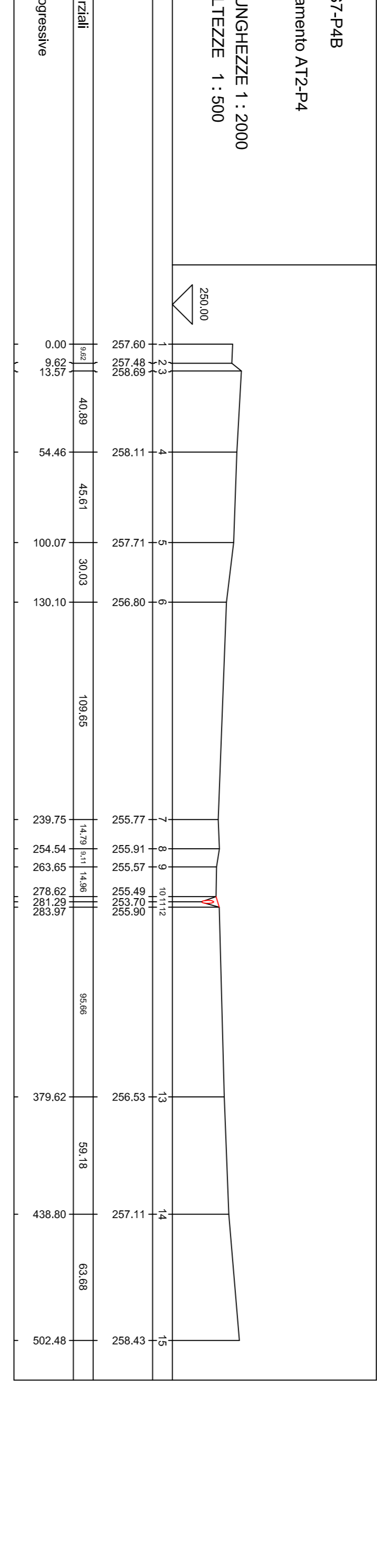

Completamento	Espresso 04				
PAI ANTERO A.M.A.	MASTRANGELO AB				
OPERA S.R.L.	1013901				
02	REVISIONE	D. Croce	Matteo Pini	Matteo Pini	
01	REVISIONE	D. Croce	Matteo Pini	Matteo Pini	
00	EMISSIONE	D. Croce	Matteo Pini	Matteo Pini	
Rev	Data	Devisione	Preparata	Verificata	Approvata
			Matteo Pini	Matteo Pini	Matteo Pini

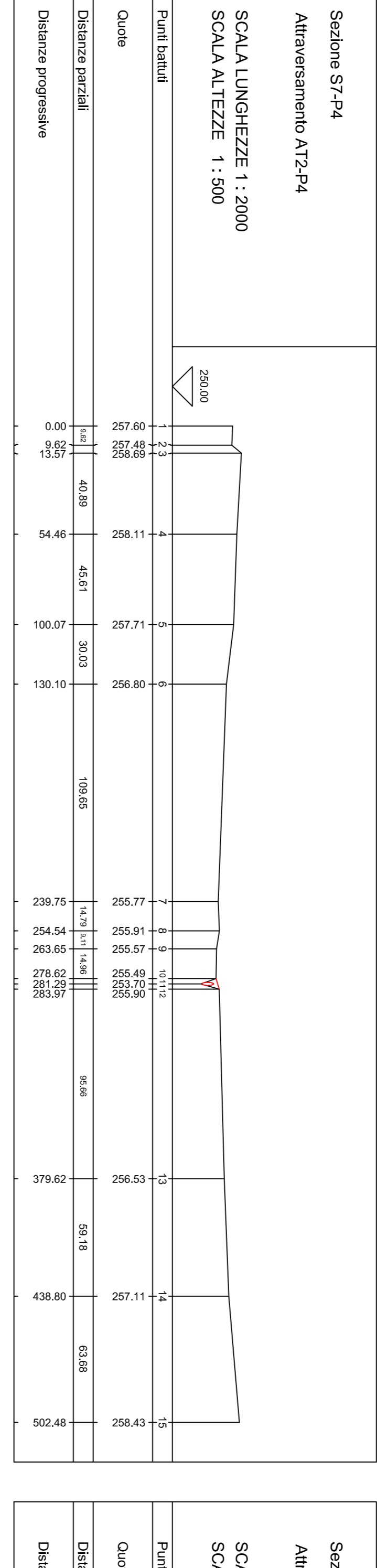
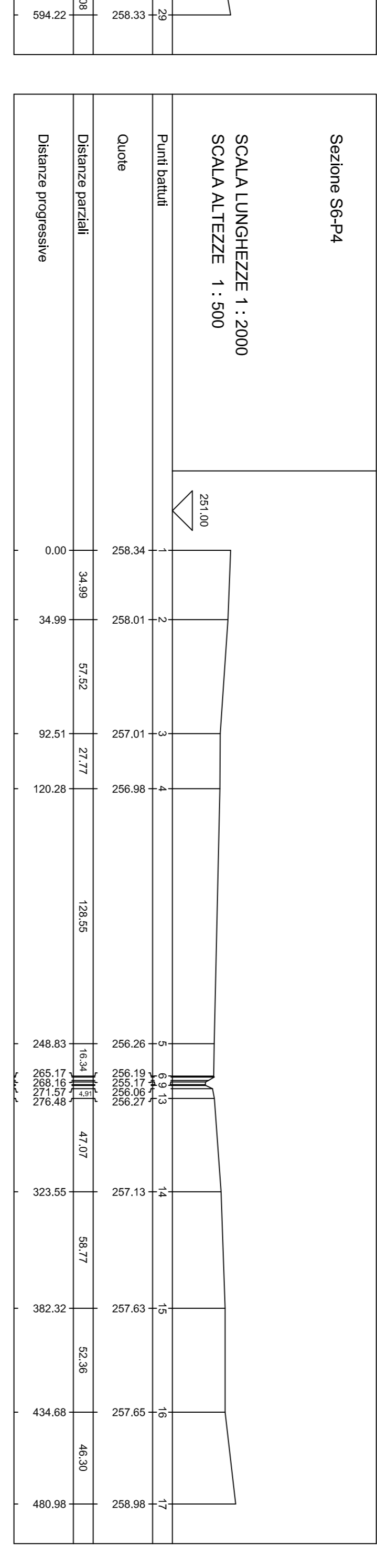
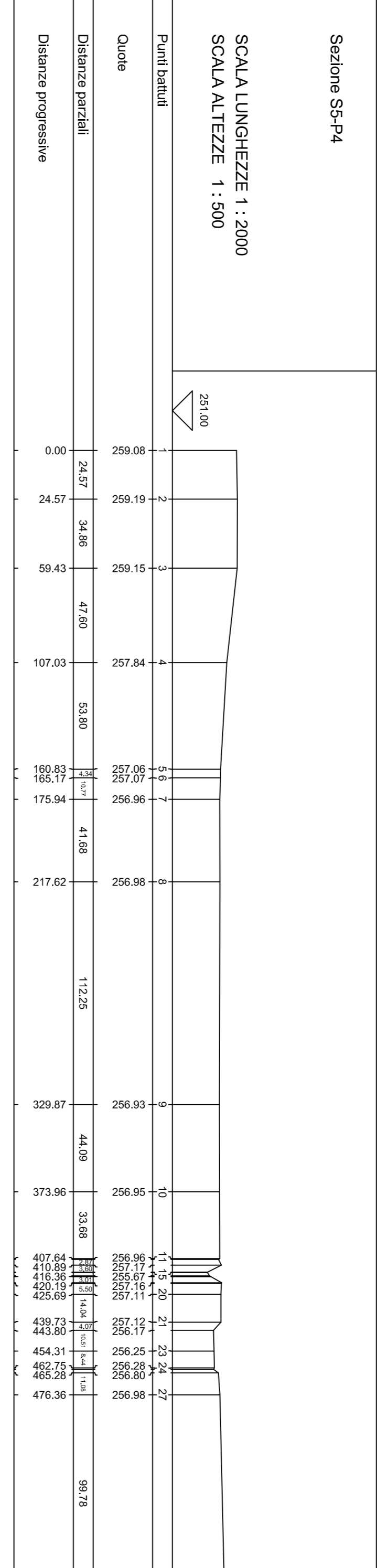
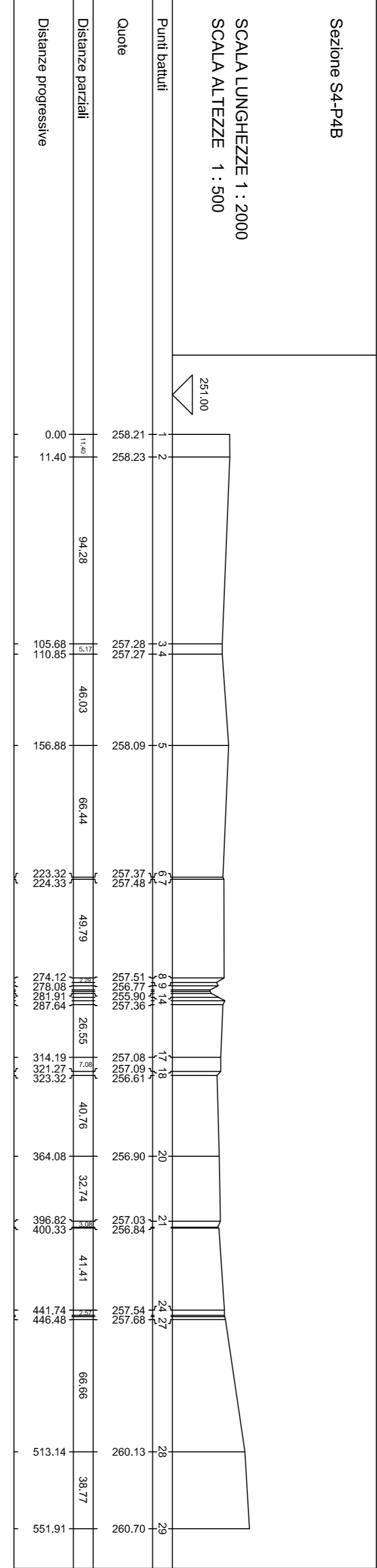
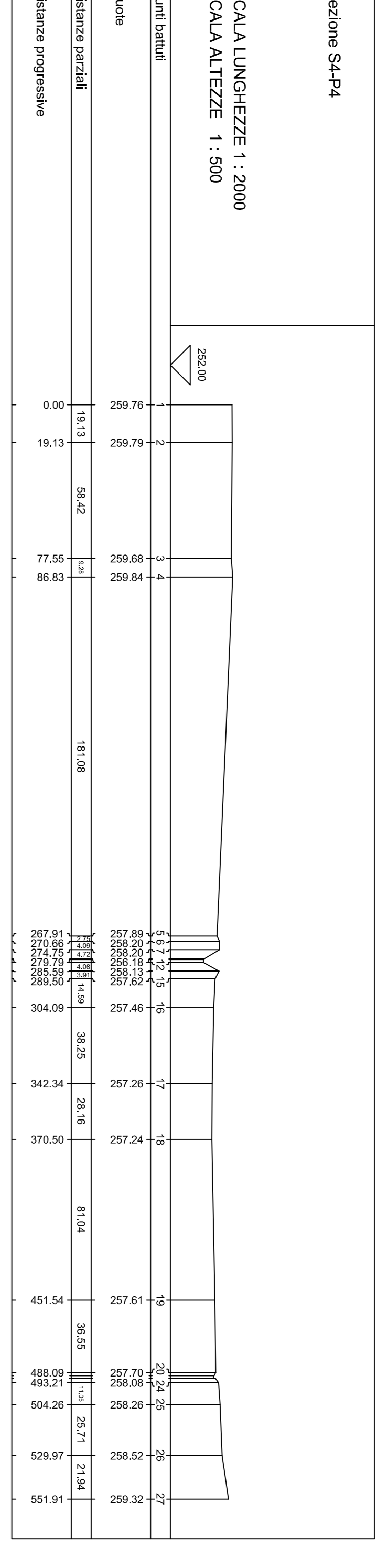
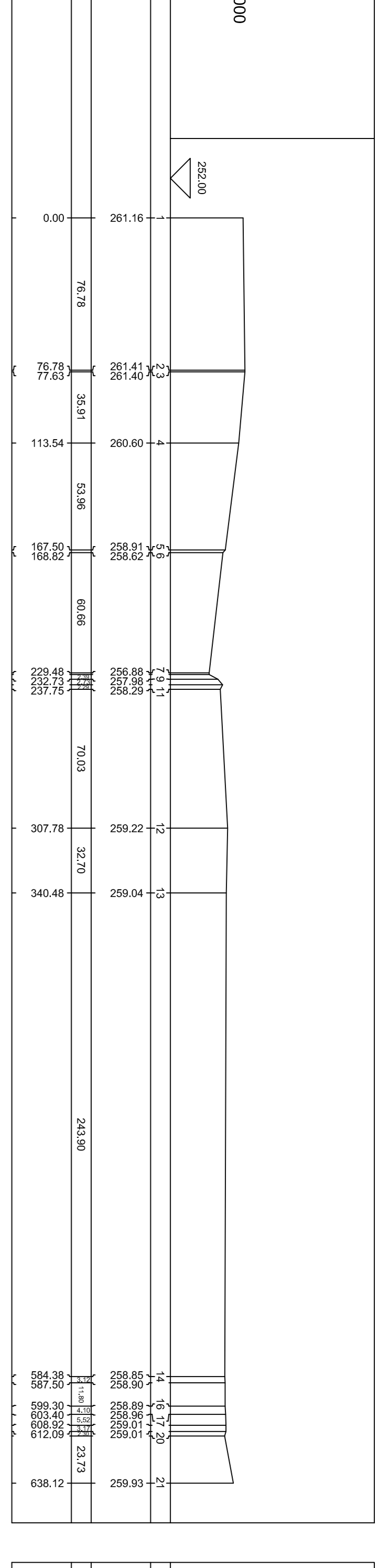
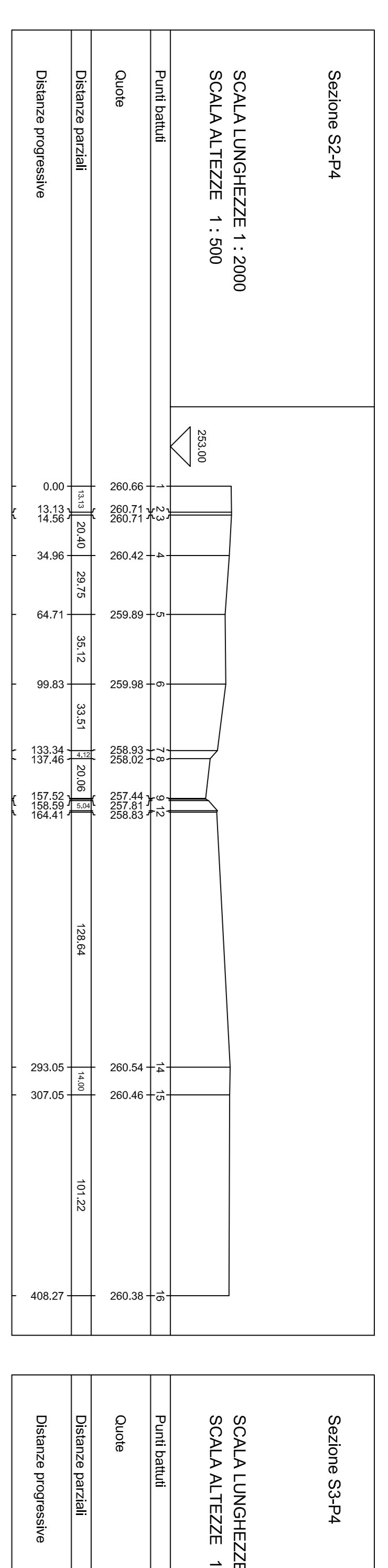
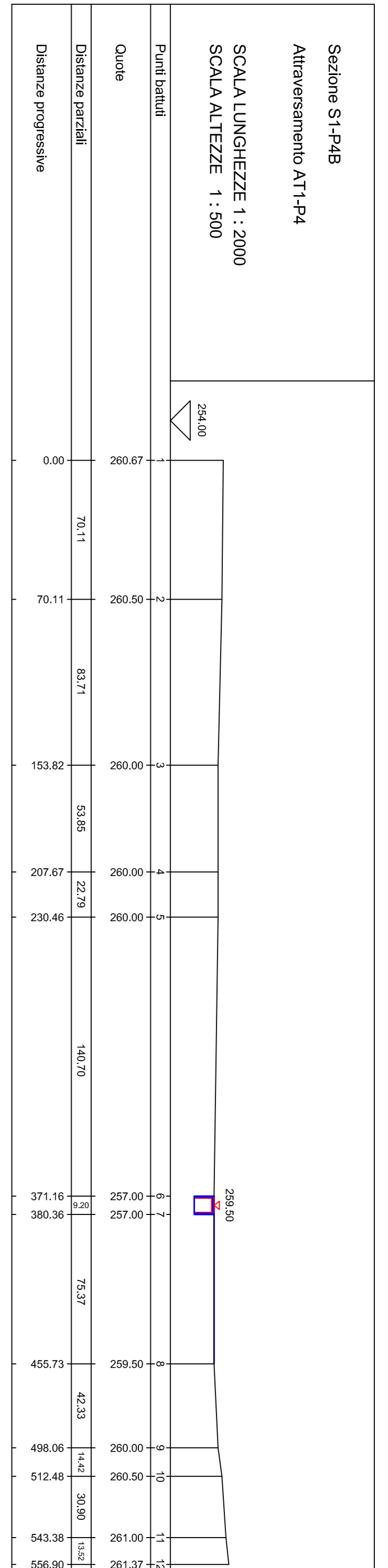
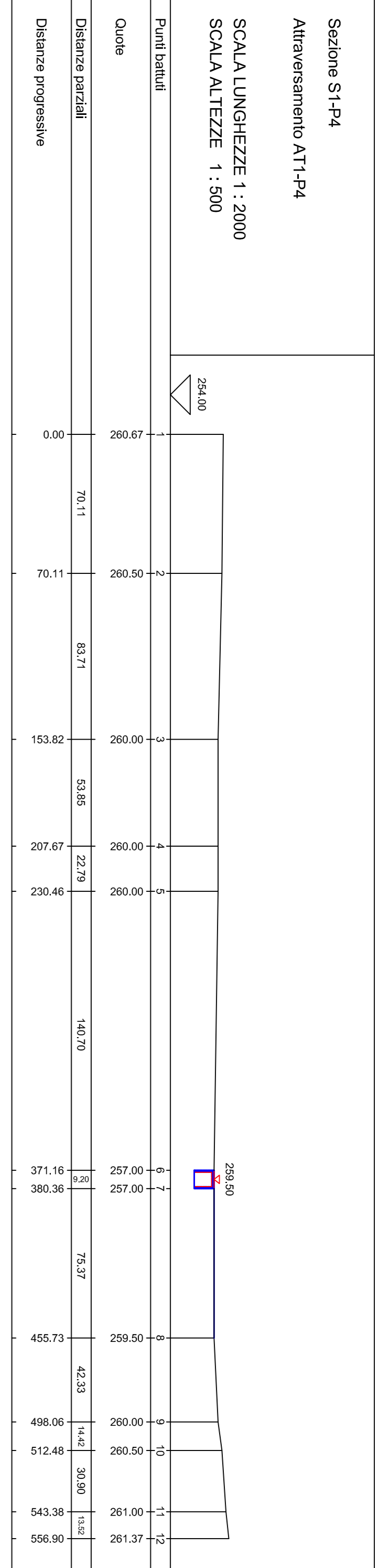